



www.innovatires.com

 **INNOVA TIRE**

2025
BIKE TIRES

About Us

Innova Rubber Co., Ltd. was founded in 1995, headquarters in Changhua, Taiwan; factories at Taiwan and China, mainly producing bicycle tires; wheelchair tires; baby stroller tires and all kinds of leisure race tires such as ATV tires; golf cart tires; motocross tires and others.

The company aims to focus on the creation of innovation, the pursuit of quality and customer satisfaction.

Innova has an excellent R&D team and strong production bases in Taiwan and China. Our factories are all awarded ISO -9001 certification to ensure the production of the best tires/tubes and to deliver the best quality to the final consumers for the trust of customers.

Innova, pursuit of innovation is a never-ending effort, has developed a number of global patents including the new patterns, new tire structures, as well as new products.

We believe our constantly improvement in product quality and customer service will eventually make Innova become a household name synonymous with quality and value.

INDEX OF CONTENTS

- 03 INNOVA ESG
- 05 E-BIKE TIRES
- 10 BMX BIKE TIRES
- 16 MOUNTAIN BIKE TIRES
- 21 GRAVEL BIKE TIRES
- 22 CITY BIKE TIRES
- 26 ROAD BIKE TIRES
- 28 FAT & PLUS SIZE TIRES
- 30 MINI & FOLDING BIKE TIRES
- 31 SNOW STUD TIRES
- 32 BEACH CRUISER TIRES
- 33 ANTI-PUNCTURE SERIES
- 34 COLOR DEMOSTRATION
- 35 INNER TUBES & VALVES
- 36 GENERAL DATA



INNOVA ESG



SOLAR ENERGY



Environmentally friendly energy use

The use of solar power generation equipment on the factory roof can generate approximately 4.3 million kilowatt-hours of power for self-use every year, thus reducing the use of other energy sources in China factory.

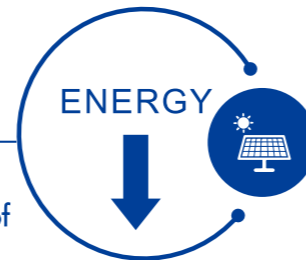

Reduced gas emissions

INNOVA uses natural gas instead of heavy oil combustion, and the boiler carbon dioxide emissions can save 80 kg/ton per ton of steam in Taiwan and China factory.

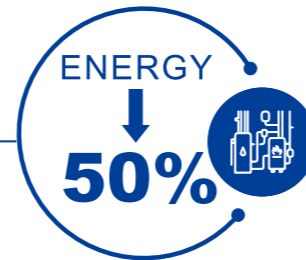

Restore a large number of trees and sustainable organisms

Actively restore trees in the factory area to reduce carbon dioxide emissions in China factory.

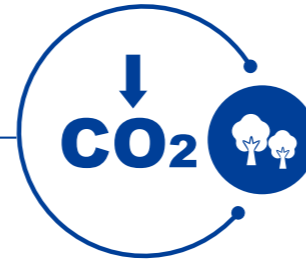

Material recycling

INNOVA use recycled fishing nets to make tire casing + recycled carbon black + recycled rubber + carbon black-free formula in Taiwan and China factory .

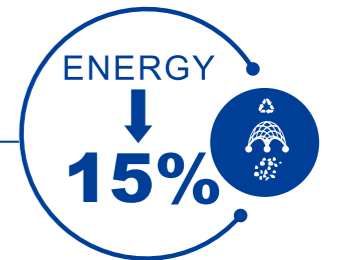

Energy-saving ventilation equipment

INNOVA uses environmentally friendly ventilation equipment for rest and standby, which can save 17% of electricity every month in Taiwan and China factory .

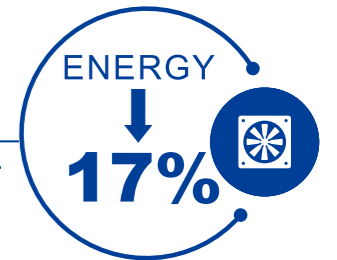

Production equipment energy-saving system

Extruders, air compressors, and other related equipment in the factory all use variable frequency voltage systems, which can save about 50% of electricity every month in Taiwan and China factory.

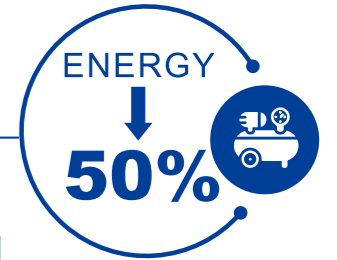



E-BIKES



E-25

For E-BIKES up to 25 km/h.

E-CARGO

Be recommended with Super Guard - special 6 ply tire construction for e-cargo. Not only enhances the puncture protection, but also increases the sidewall stiffness.

E-25 / E-CARGO



E-25/E-CARGO



E-CARGO



20x2.4
24x2.4
27.5x2.4

IB-3027

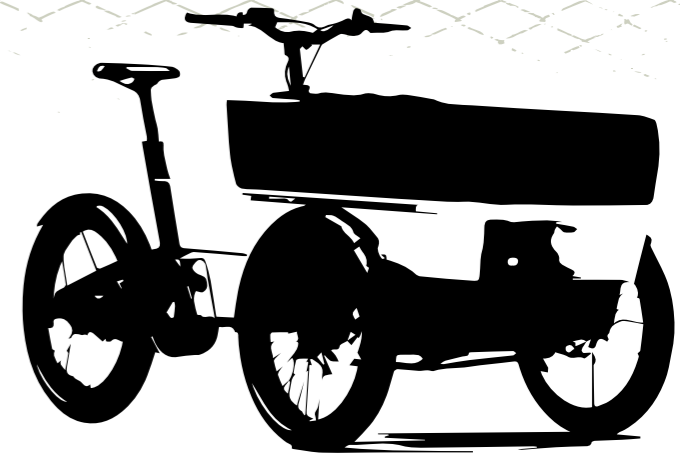

NEW

20x4.0
20x4.5

IA-3025



12 1/2 x 1.75 x 2 1/4
16x1.75
20x1.75

IA-2616



NEW

24x2.0
27.5x2.0
27.5x2.20

IA-2155



12 1/2 x 3.0 (IA-5189)
16x3.0
20x3.0 (IA-5189)
24x3.0 (IA-5189)
20x4 1/4

HV-5189



20x2.0
20x2.2
20x2.3
20x2.4
26x2.2
27.5x2.3
29x2.3

IA-2128



20x3.0
24x3.0

IA-2018

E-25/E-CARGO

E-25/E-CARGO

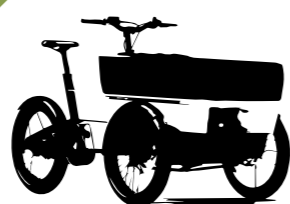

20x2.125
24x2.125
24x3.0
26x2.125
26x2.35
26x3.0

IA-2236



20x4.0

IA-2152



20x2.25 27.5x2.8
20x2.4 29x2.25
20x2.6 29x2.4
20x2.8
24x2.25
24x2.8
26x2.25
26x2.8
27.5x2.25

IB-3014



26x4.0
26x4.8

LV-1008



20x1.95
24x1.95
700x40C
700x45C
700x50C

IB-3010



26x1.75
700x38C
700x45C

IA-2068



20x2.0
20x2.25

IA-2248



26x2.25
27.5x2.10
29x2.25
700x40C

IA-2549



26x2.10
27.5x2.10
27.5x2.8
29x2.10
29x3.0

IA-2569



700x32C
700x35C

IA-2406



20x1.75
24x1.75
26x1.75
650Bx47C
700x45C

IB-3016



20x2.125(IA-2069B)
26x2.125

IA-2069



20x2.40
26x2.3
26x3.0
26x4.0
29x3.0

IA-2610



20x4.0

IA-2579



16x4.0
20x4.0
24x4.0
26x4.0 (LV-1003E)
27.5x3.0

LV-1003



26x2.0
27.5x2.0
700x38C

IA-2562



26x2.0
27.5x2.0
700x42C
700x45C

IA-2066



26x1.75
26x2.8
27.5x1.75
29x1.75(700x45C)
700x35C
700x38C
700x52C

IA-2084



E-25/E-CARGO



700x40C
700x45C
700x52C

IA-2209



27.5x1.75
700x38C

IB-3013



29x1.75
(700x45C)

IB-3025



20x2.125
22x1.95
22x2.125
24x1.95

IA-2209B



26x2.0
700x35C
700x38C

IB-3019



29x2.15

IB-3026



24x2.0
700x52C

IA-2150



700x42C

IB-3020



29x1.75
(700x45C)

IB-3028

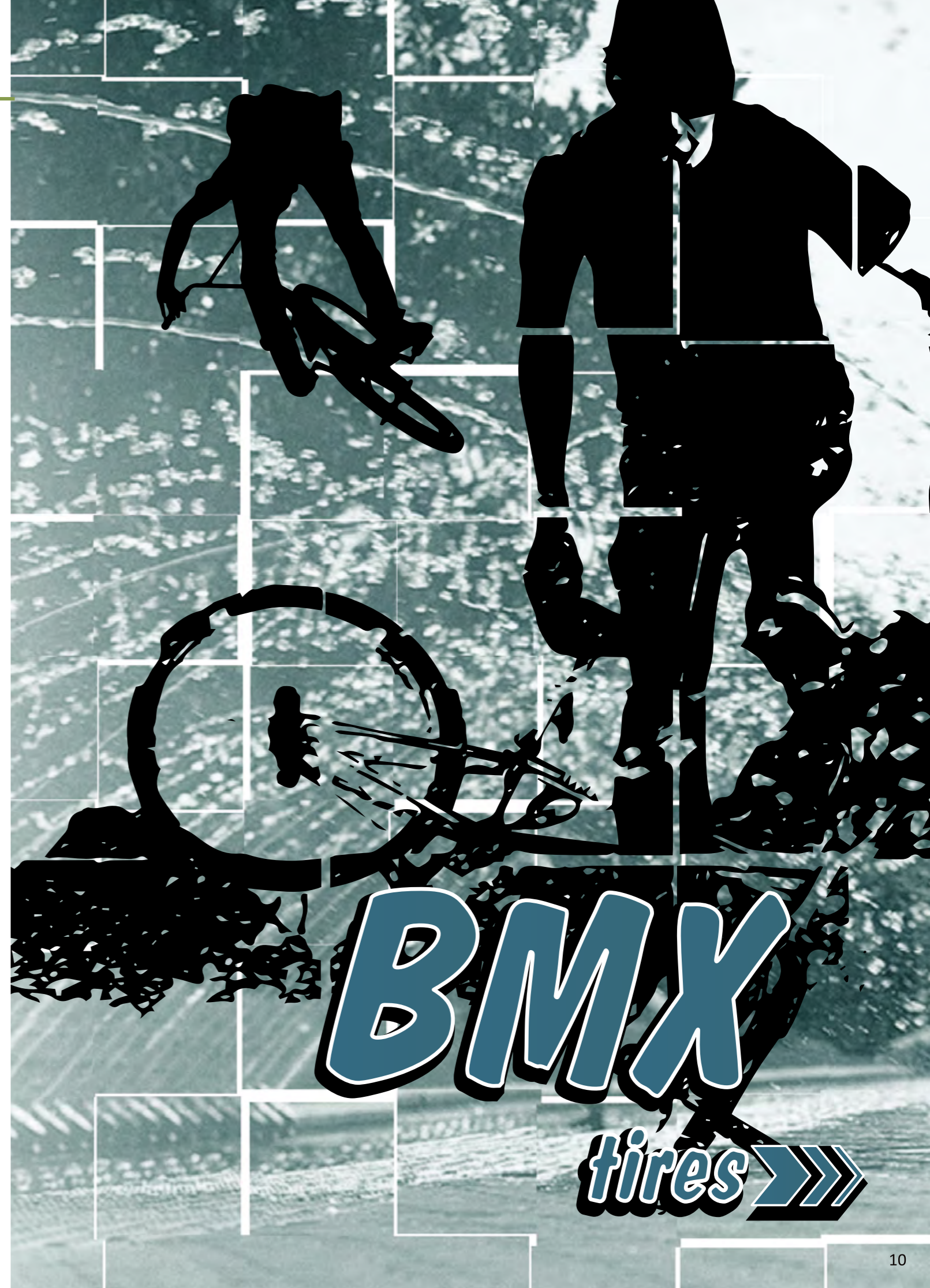

BMX

tires >>>

BMX TIRES

BMX TIRES



BMX TIRES

BMX TIRES



12 1/2x1.75 x2 1/4
12 1/2x2 1/4
16x1.75
16x2.125
16x2.25
18x2.25

IA-2094



12 1/2x2 1/4
16x1.75

IA-2103



12 1/2x2 1/4
16x2.125
20x1.95

IA-2116



20x2.10
20x2.25

IA-2131



20x2.0
20x2.125
24x1.95

IA-2249



20x2.0

IA-2503



20x2.0
20x2.20
26x2.5
29x2.5

IA-2096



20x1.75
20x2.125

IA-2104



20x2.0
20x2.20

IA-2127



20x1.90
20x2.10

IA-2239



20x1.75
20x2.0

IA-2501



20x2.0
20x2.25
22x2.125

IA-2505



12 1/2x2 1/4
16x1.75
16x2.125
20x1.75
20x2.125

IA-2101



20x2.125

IA-2105



12 1/2x2 1/4
14x2.10
16x1.75
16x2.10
18x2.10 22x2.3
20x1.75 24x2.0
20x2.0 26x2.0
20x2.20 26x2.20
20x2.30 27.5x2.3
20x2.4 29x2.30

IA-2128



20x2.0
20x2.25

IA-2248



20x1.75
20x2.0

IA-2502



Billboard Tire
20x2.125

IA-2533

BMX TIRES



20x2.125

IA-2534



12 1/2x2 1/4
12 1/2x1.75x2 1/4
14x1.75
16x1.75
16x2.25
20x1.75
22x1.75
24x1.75

IA-2603



12 1/2x2 1/4

IA-2617

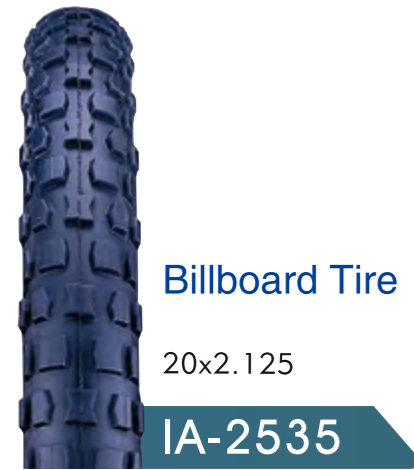

Billboard Tire

20x2.125

IA-2535



12 1/2x2 1/4
14x2.25
16x2.4
18x2.4
20x2.4
26x2.3

IA-2610



20x2.3
20x2.40

IB-3009



12x1.75
12x2.0
14x2.0
16x2.0
18x2.0

IA-2579



12 1/2x2 1/4

IA-2611



12 1/2x2 1/4
16x1.75

SA-001

MTB TIRES



12 1/2x2 1/4
14x2.125
16x1.95
16x2.125
18x1.95
20x1.75
20x1.95
20x2.10
20x2.125

24x1.75
24x1.90
24x1.95
24x2.10
26x1.75
26x1.90
26x1.95
26x2.10

IA-2004



20x1.75
20x2.125
24x1.75
24x1.90
24x2.125
26x1.90
26x1.95

HV-5002



26x1.95

IA-2001



12 1/2x 2 1/4
16x2.125
20x1.75
20x2.0
22x1.75
24x1.50
24x1.95

26x1.50
26x1.75
26x1.90
26x1.95
26x2.10
26x2.35

IA-2005



20x2.10
24x2.10
26x2.10
29x2.10

IA-1130



24x1.95
24x2.10
26x1.95
26x2.10

IA-2001N



24x1.95
26x1.95

IA-2005A



26x2.0
29x2.0

IA-1131



16x2.10
18x2.10
20x2.10
24x1.75
24x1.95
24x2.10
26x1.75
26x1.95
26x2.10

IA-2003



24x2.125
26x2.125

IA-2006



MTB TIRES

MTB TIRES



16x1.95
20x1.95

IA-2015



16x2.125
26x2.0

IA-2020



16x1.75
18x1.75
20x1.75
22x1.95
24x1.75
24x1.95
26x1.75
26x1.95

IA-2007



20x2.0
26x2.0

IA-2012



16x2.125
20x1.95
24x2.0
26x2.0
700x35C
700x45C
(28x1.75)

IA-2016



20x2.0
24x2.0
26x2.0
700x38C

IA-2022



20x1.95
22x2.125
24x1.50
24x1.95
26x1.95

IA-2026



26x2.0

IA-2071



24x2.10
26x1.95
26x2.10

IA-2010



26x1.75
26x1.90
26x1.95
700x35C

IA-2013



26x2.0

IA-2017



16x1.35
20x1.35
26x2.0
700x38C
700x42C

IA-2023



26x1.95

IA-2063



26x1.95

IA-2111



24x1.95
26x1.95
26x2.10

IA-2011



24x1.75
26x1.75
26x1.95
700x35C

IA-2014



26x2.0

IA-2019



16x2.0
20x2.0
20x2.25
24x2.0
24x2.35
26x2.0
26x2.35

IA-2024



20x2.0
24x2.0

IA-2070



26x1.95

IA-2112

MTB TIRES

MTB TIRES



26x2.0
26x2.20

IA-2548



29x1.95
29x2.10

IA-2554



29x2.0

IA-2563



20x1.95
24x1.95
26x1.75
26x2.0
26x2.25
27.5x1.95
27.5x2.10
29x2.10
29x2.25

IA-2549



29x2.0

IA-2560



29x2.0

IA-2564



20x2.10
24x2.10
26x2.10
27.5x2.10
29x2.10

IB-2003



26x2.1

IA-2113



26x2.0

IA-2540



24x2.35
26x2.0
26x2.35
27.5x2.35

IA-2530



26x2.0

IA-2542



26x2.0
26x2.35
27.5x2.10

IA-2552



24x2.0
26x2.0

IA-2561



26x2.10
27.5x2.35
29x2.10

IA-2568



26x2.10
27.5x2.10
27.5x2.25

IB-2157



26x2.0
700x45C
(28x1.75)

IA-2531



26x2.0
26x2.35

IA-2545



29x1.95
29x2.10

IA-2553



26x1.75
26x2.0
27.5x2.0

IA-2562



14x2.10
16x2.10
18x2.125
20x2.0
24x2.0
26x2.10
26x2.25
26x2.4
27.5x2.10
27.5x2.25
29x2.10

IA-2569



12x2.25
14x2.25
16x2.25
18x2.25
20x2.25
20x2.4
20x2.6
20x2.8
24x2.25
24x2.8
26x2.25
26x2.8
27.5x2.25
27.5x2.8
29x2.25
29x2.4

IB-3014

GRAVEL TIRES

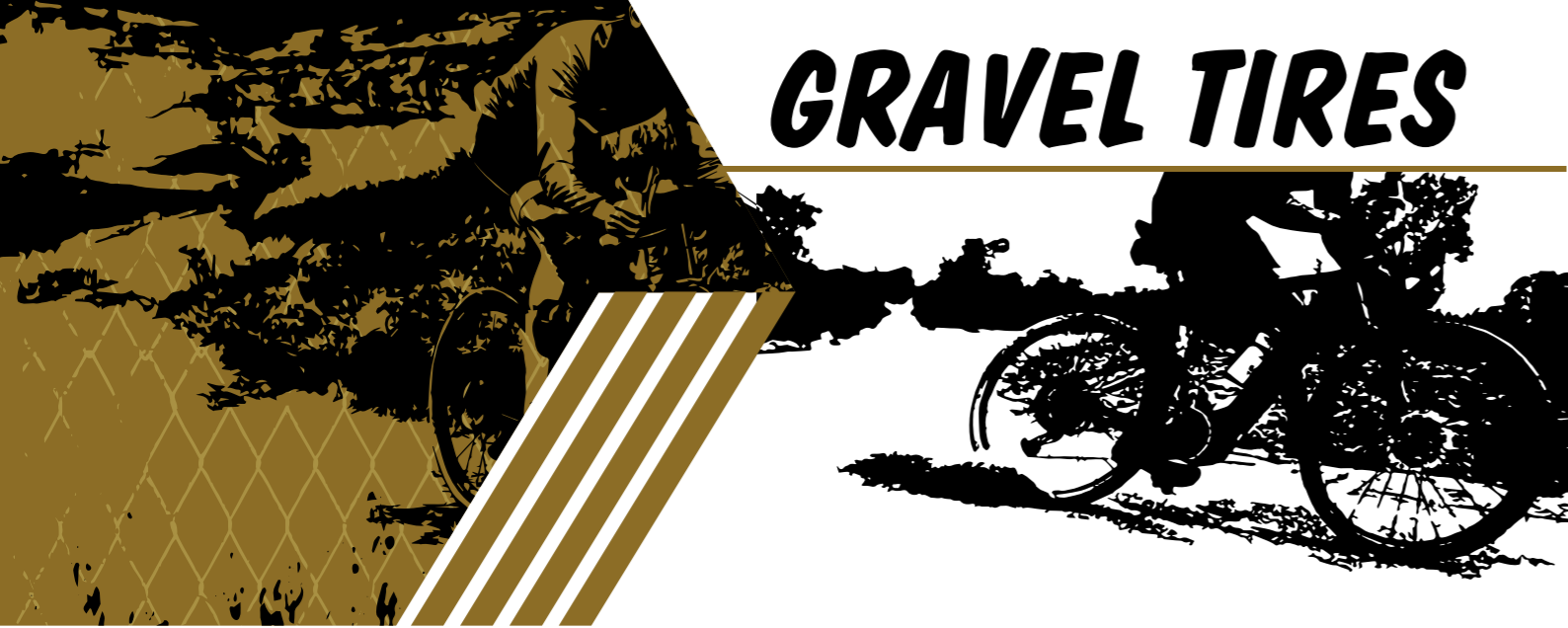

CITY TIRES



12 1/2x3.0
 14x1.95 20x2.0
 16x2.75 20x3.0
 (IA-2065B) 20x4 1/4
 16x3.0 22x2.5
 18x1.95 24x2.10

IA-2065



700x40C
 700x45C
 700x50C

IB-3010



700x38C

IB-3018



27.5x1.95
 27.5x2.10
 29x2.10
 29x2.25
 700x40C

IA-2549



12 1/2x3.0
 16x3.0
 18x1.95
 20x2.0
 20x3.0
 20x4 1/4
 24x2.10
 24x3.0

HV-5189



24x1.75

IA-2009



16x1.75 27.5x2.0
 20x1.95 28x1.75
 24x1.75 700x38C
 24x1.95 700x40C
 26x1.75 700x42C
 26x2.0 700x45C

IA-2066



650Bx47C
 700x45C

IB-3016



29x1.75
 (700x45C)

IB-3028



27.5x2.0
 700x32C
 (28x1 5/8x1 1/4)
 700x35C
 (28x1 5/8x1 3/8)
 700x38C

IA-2562



24x1 3/8
 26x1 3/8
 28x1 1/2

HV-5204



12 1/2x2 1/4
 16x2.125
 20x3.0
 24x1.50 26x1.50
 24x2.0 26x1.75
 24x3.0 26x2.0
 26x1.25 26x2.35

IA-2018



20x1.50
 20x1.75
 24x1.75
 26x1.75

IA-2067



20x2.125
 24x1.75
 26x1.90
 26x2.125

IA-2008



16x1.50
 26x1 3/8

IA-2054



26x1.75
 700x35C
 700x38C
 700x45C
 (28x1.75)

IA-2068



CITY TIRES

CITY TIRES



24x1.50
24x1.75 700x35C
26x1 3/8 700x38C
26x1.50 700x40C
26x1.75 700x45C
28x1 1/2 700x52C

IA-2209



26x1.50
26x1.75
26x2.0
700x35C

IA-2235



16x1.95
20x2.0
20x2.125
26x2.125

IA-2073



20x1 3/8
22x1 3/8
22x1 3/4
24x1 3/8
26x1 3/8
27x1 3/8
27x1 1/4

IA-2202



24x1 3/8
26x1 3/8
26x1 3/4
27x1 3/8

IA-2210B



20x2.125 **NEW**
24x2.125
24x3.0
26x2.0
26x2.125
26x2.35 **NEW**
26x3.0

IA-2236



700x35C
700x38C

IA-2252



24x1.25
26x1.25
700x28C
700x32C
700x35C

IA-2406



24x1 3/8
26x1 3/8

IA-2074



20x1 3/8
22x1 3/8
24x1 3/8
26x1 3/8
27x1 3/8

IA-2205



700x40C

IA-2216



26x1.50
26x2.0

IA-2245



24x1 3/8
26x1 3/8
700x35C
700x38C
700x45C

IA-2401



700x40C

IA-2549



12x1.50	20x1 3/8	24x1.50	27.5x1.50
12x1.75	20x1.50	24x1.75	29x1.75
14x1.50	20x1.75	26x1 3/8	700x35C
14x1.75	20x1.95	26x1.50	700x38C
16x1.50	22x1 3/8	26x1.60	700x52C
16x1.75	22x1.50	26x1.75	
18x1.50	22x1.75	26x2.8	
18x1.75	24x1 3/8	27.5x1.75	

IA-2084



26x1.50
26x1.75
700x38C

IA-2231



26x1.50

IA-2251



26x1 1/2
26x1 3/8
26x1 3/8x1 1/2
26x1 5/8x1 1/2
27x1 1/2
27x1 1/4
28x1 5/8x1 1/2
28x1.75
700x35C
700x38C

IA-2403



700x32C
700x35C
700x38C
700x44C **NEW**

IA-2562

CITY TIRES



ROAD tires >>>



ROAD TIRES

FAT TIRES



27.5x3.2

LV-1006



12 1/2x3.0
16x3.0
20x4 1/4
20x3.0
24x3.0

HV-5189



700x23C
700x25C
700x28C

IA-2319



24x4.0
26x4.0

LV-1001



24x4.8
26x4.0
26x4.8
27.5x4.5

LV-1007



20x3.0
24x3.0

IA-2018



700x40C
700x45C
700x50C

IA-2307



700x23C

IA-2309



24x1 (25-540)
25x1
26x1

IA-2806S



26x4.0

LV-1002



26x4.0
26x4.8

LV-1008



12 1/2x3.0

IA-2021



700x23C (IA-2308)
700x25C (IA-2886)
16x1 3/8 (IA-2886)

IA-2308
IA-2886



700x23C
700x25C
700x28C

IA-2318



700x23C
700x25C

LA-1002



16x4.0
20x4.0
24x4.0
26x4.0 (LV-1003E)
27.5x3.0

LV-1003



26x4.0

LV-1009



26x3.0

IA-2047

FAT TIRES

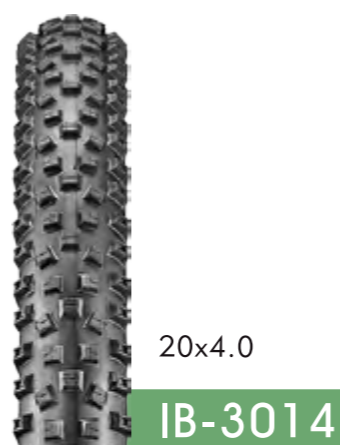
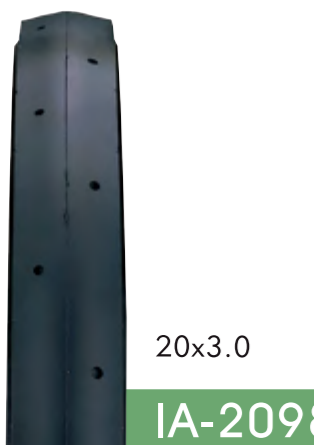
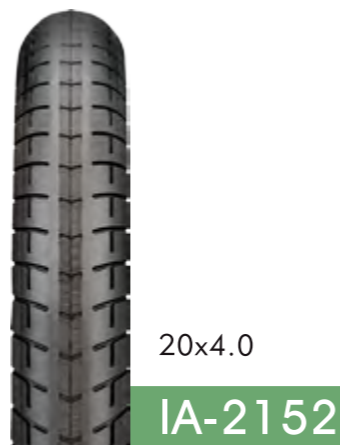
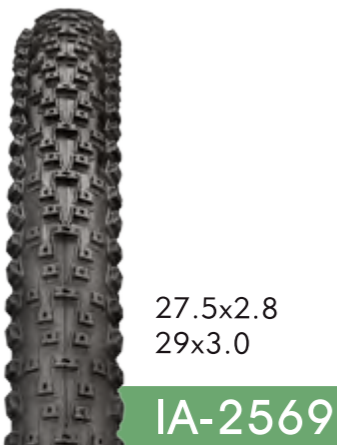

MINI TIRE

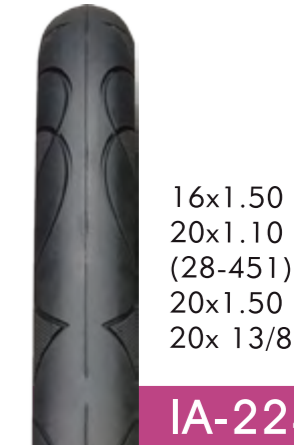

SNOW TIRES



27.5x2.10
(184 spikes)
29x2.10
(184 spikes)

IA-2572



26x1.75/1.9
(104 spikes)
700x35C
(110 spikes)
700x38C
(110 spikes)
700x45C
(114 spikes)

IA-2902



29x2.10
(300 spikes)

IA-2573



26x1 3/8
(164 spikes)

IA-2903



26x2.10
(268 spikes)

IA-2901



700x35C
(120 spikes)
700x45C
(120 spikes)

IA-2908

BEACH TIRES



20x1.75
20x2.125
(IA-2069B)
22x1.75
26x2.125

IA-2069



24x2.125
26x2.125

IA-2702



24x2.125
26x2.125
26x3.0
27.5x2.35

IA-2704

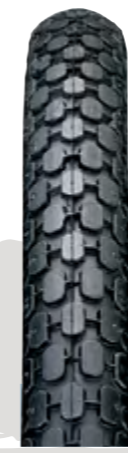

24x2.125
26x2.125

IA-2701



26x2.125

IA-2703

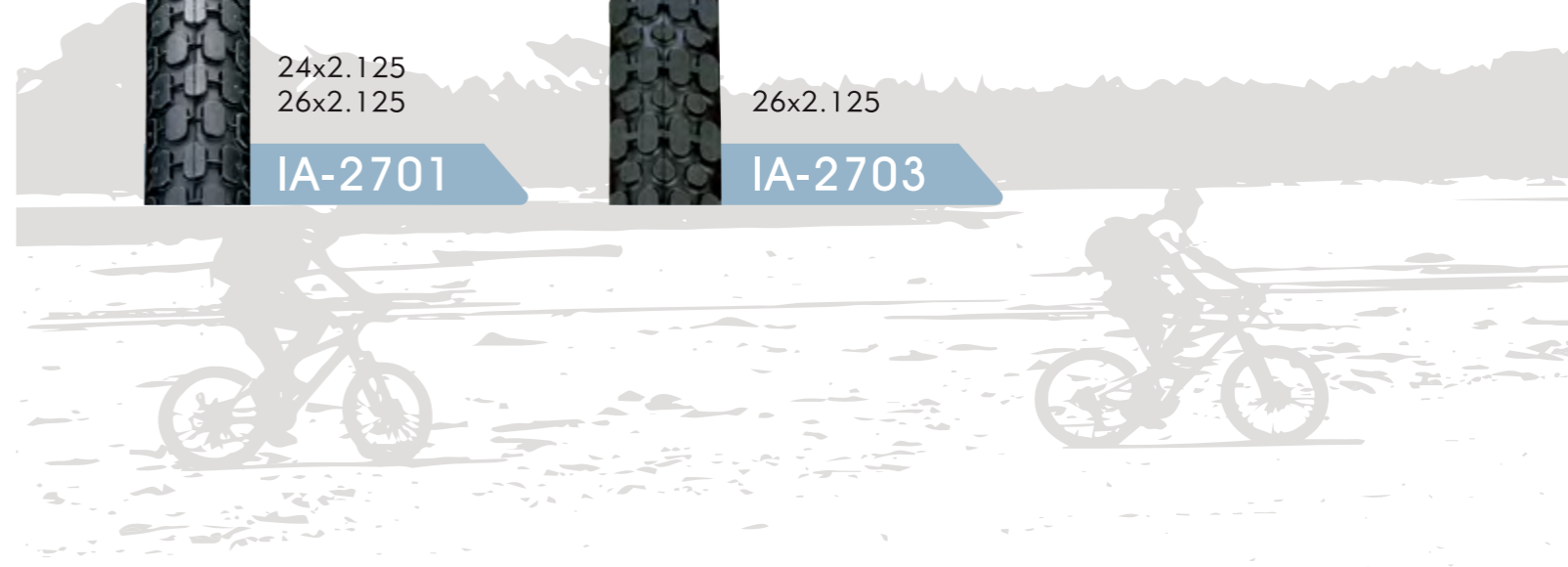

Anti-Puncture

Innova protection system for puncture & cut proof



Color Demonstration

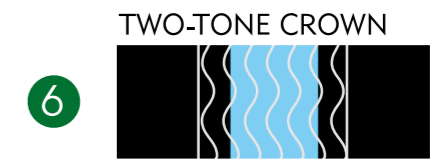
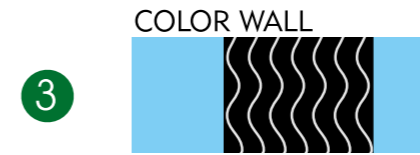
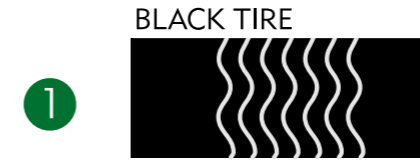

COLOR	PANTONE COLOR	FACTORY COLOR
BLACK		BK
WHITE		WH
PURPLE	2665C	PU
RED	201C-202C	RE
DARK GRAY	430U-431U	DGR
MIDDLE GRAY	7543C-7544C	MGR
LIGHT GRAY	7543U-7544U	GR
DARK BLUE	288C-289C	BL
LIGHT BLUE	293C-294C	FB
PURPLE BLUE	273C	UB
YELLOW	124C	YE
CREAMY YELLOW	122C	MY
PINK	190C	PK
LIGHT PINK	211C-212C	LPE
GRASS GREEN	354C-355C	JG
ORANGE	157C-158C	OR
DARK GREEN	347C-348C	DG
LIGHT GREEN	325C-326C	JE
DARK COFFEE	1545C	HCF
CREME	7506C-7507C	LRY
LIGHT CREME	7499C	LYE

TREAD & COLOR WALL

*Colors distribution can be negotiated.

*Colors are similar to pantone color but ain't guaranteed exactly the same.

ALL SIZE AVAILABLE



TUBE & PACKING BOX



DUNLOP VALVE (D/V)
(GERMANY TYPE)



FRENCH VALVE (F/V)
(PRESTA)



ENGLISH VALVE (E/V)

PD(G) or EP2

EG



AMERICAN VALVE (A/V)
(SCHRADER)



ITALIAN VALVE (I/V)

#9000

C

NF2

FINL

V-002
(Record)

CPF

NF2

E-BIKE (E-25/E-CARGO)

SIZE(INCH)	SIZE(MM)	RIM TYPE	PATTERN	P.S.I	PAGES
12 1/2x1.75x2 1/4	—	H.B.	IA-2616	35	P06
12 1/2x3.0	—	S.S.	HV-5189	35	P06
16x1.75	47-305	H.B.	IA-2616	35	P06
16x3.0	102-305	H.B.	HV-5189	35	P06
16x4.0	102-305	H.B.	LV-1003	35	P06
20x1.75	47-406	H.B.	IA-2616	35	P06
20x1.75	47-406	H.B.	IB-3016	30-60	P08
20x1.95	50-406	H.B.	IA-3010	35-65	P08
20x2.0	50-406	H.B.	IA-2128	35-60	P06
	50-406	H.B.	IA-2248	35-60	P07
20x2.125	58-406	S.S.	IA-2069	40	P08
	57-406	H.B.	IA-2209B	35	P09
20x2.2	54-406	H.B.	IA-2236	35	P07
	56-406	H.B.	IA-2128	35-60	P06
20x2.25	58-406	H.B.	IA-2248	35-65	P07
	58-406	H.B.	IB-3014	35-65	P07
20x2.3	58-406	H.B.	IA-2128	35-60	P06
	60-406	H.B.	IA-2610	35-60	P07
20x2.4	60-406	H.B.	IB-3014	35	P07
	60-406	S.S.	IB-3027	35-60	P07
	60-406	H.B.	IB-2128	35-60	P06
20x2.6	66-406	H.B.	IB-3014	30-60	P07
20x2.8	70-406	S.S.	IB-3014	15-30	P07
20x3.0	76-406	H.B.	IA-2018	40	P06
	72-406	H.B.	HV-5189	35	P06
20x4 1/4	—	S.S.	HV-5189	35	P06
	102-406	H.B.	IA-2152	35	P07
20x4.0	102-406	H.B.	IA-2579	35	P07
	—	H.B.	LV-1003	35	P07
	—	S.S.	IA-3025	35	P06
20x4.5	—	S.S.	IA-3025	5-15	P06
22x1.95	54-456	H.B.	IA-2209B	40-65	P09
22x2.125	57-456	H.B.	IA-2209B	45	P09
24x1.75	47-507	H.B.	IB-3016	30-60	P08
	54-507	H.B.	IA-2209B	40-65	P09
24x1.95	50-507	H.B.	IB-3010	35-65	P08
	52-507	H.B.	IA-2150	40-65	P09
24x2.0	50-507	H.B.	IA-2155	40-65	P06
24x2.125	57-507	H.B.	IA-2236	35-65	P07
24x2.25	58-507	H.B.	IB-3014	35-65	P07
24x2.4	62-507	S.S.	IB-3027	35-60	P06
24x2.8	70-507	S.S.	IB-3014	15-30	P07
	76-507	H.B.	IA-2018	40-65	P06
24x3.0	74-507	H.B.	IA-2236	40-65	P07
	74-507	H.B.	HV-5189	40-65	P06
24x4.0	—	H.B.	LV-1003	35	P07
	47-559	H.B.	IA-2068	40-65	P08
26x1.75	47-559	H.B.	IA-2084	40-65	P08
	47-559	H.B.	IB-3016	40-65	P08
	54-559	H.B.	IB-2066	40-65	P08
26x2.0	50-559	H.B.	IA-2562	35-65	P08
	50-559	H.B.	IB-3019	30-60	P09
	54-559	S.S.	IA-2569	35-65	P07
26x2.10	57-559	H.B.	IA-2069	40-65	P08
26x2.125	57-559	H.B.	IA-2236	35-65	P07
26x2.2	56-559	H.B.	IA-2128	35-60	P06
	58-559	H.B.	IA-2549	35-65	P07
26x2.25	58-559	H.B.	IB-3014	35-65	P07
	58-559	H.B.	IA-2610	35-60	P07
26x2.3	58-559	H.B.	IA-2610	35-60	P07
26x2.35	59-559	H.B.	IA-2236	40-65	P07

E-BIKE (E-25/E-CARGO)

SIZE(INCH)	SIZE(MM)	RIM TYPE	PATTERN	P.S.I	PAGES
26x2.8	71-559	S.S.	IA-2084	35-65	P08
	70-559	S.S.	IB-3014	35-65	P07
26x3.0	76-559	S.S.	IA-2236	40-65	P07
	76-559	S.S.	IA-2610	35	P07
26x4.0	102-559	S.S.	IA-2610	35	P07
	—	S.S.	LV-1003E	5-15	P07
26x4.8	—	S.S.	LV-1008	5-15	P08
	—	S.S.	LV-1008	5-15	P08
27.5x1.75	47-584	S.S.	IA-2084	40-65	P08
	47-584	S.S.	IB-3013	40-65	P09
27.5x2.0	50-584	S.S.	IA-2066	40-65	P08
	50-584	S.S.	IA-2562	30-60	P08
	50-584	H.B.	IA-2155	40-65	P06
27.5x2.10	54-584	S.S.	IA-2549	35-65	P07
	54-584	S.S.	IA-2569	35-65	P07
27.5x2.20	—	H.B.	IA-2155	—	P06
27.5x2.25	58-584	S.S.	IB-3014	35-65	P07
27.5x2.3	58-584	S.S.	IA-2128	35-60	P06
27.5x2.4	62-584	S.S.	IB-3027	35-60	P06
27.5x2.8	—	S.S.	IA-2569	15-30	P07
	70-584	S.S.	IB-3014	15-30	P07
27.5x3.0	—	S.S.	LV-1003	15-30	P07
650Bx47C	57-584	S.S.	IB-3016	30-60	P08
29x1.75	47-622	S.S.	IA-2084	40-65	P06
	45-622	S.S.	IB-3025	45-65	P09
29x2.10	45-622	S.S.	IB-3028	45-65	P09
	54-622	S.S.	IA-2569	35-65	P07
29x2.15	55-622	S.S.	IB-3026	30-60	P09
	56-622	S.S.	IA-2549	35-65	P07
29x2.25	58-622	S.S.	IB-3014	35-65	P07
	58-622	S.S.	IB-3014	35-65	P06
29x2.3	58-622	S.S.	IA-2128	35-60	P06
	60-622	S.S.	IB-3014	35-65	P07
29x2.40	—	S.S.	IA-2569	35	P07
	76-622	S.S.	IA-2610	35	P07
700x32C	32-622	S.S.	IA-2406	60-95	P08
	35-622	S.S.	IA-2084	50-75	P08
700x35C	32-622	S.S.	IA-2406	60-95	P08
	35-622	S.S.	IB-3019	50-75	P09
700x38C	40-622	S.S.	IA-2068	50-75	P08
	40-622	S.S.	IA-2084	50-75	P08
	40-622	S.S.	IA-2562	50-75	P08
	38-622	S.S.	IB-3013	50-75	P09
700x40C	38-622	S.S.	IB-3019	50-75	P09
	42-622	S.S.	IA-2209	50-75	P09
	42-622	S.S.	IA-2549	50-75	P07
700x42C	40-622	S.S.	IB-3010	50-75	P08
	44-622	S.S.	IA-2066	50-75	P08
700x45C	42-622	S.S.	IB-3020	50-75	P09
	47-622	S.S.	IA-2066	50-75	P08
	47-622	S.S.	IA-2068	50-75	P08
700x50C	47-622	S.S.	IA-2209	50-75	P09
	45-622	S.S.	IB-3016	30-60	P08
700x52C	50-622	S.S.	IB-3010	30-60	P08
	52-622	S.S.	IA-2084	40-65	P08
—	45-622	H.B.	IA-2150	40-65	P09
—	45-622	S.S.	IA-2209	40-65	P09

BMX

SIZE(INCH)	SIZE(MM)	RIM TYPE	PATTERN	P.S.I	PAGES
12 1/2x1.75x2 1/4	47-203	H.B.	IA-2603	30	P15
	47-203	H.B.	IA-2094	30	P13
12 1/2x2 1/4	57-203	H.B.	HV-1205	35	P11
	57-203	H.B.	HV-1206	28	P11
	57-203	H.B.	HV-5102	35	P11
	57-203	H.B.	HV-5104	36	P11
	57-203	H.B.	IA-2094	35	P13
	57-203	H.B.	IA-2101	30	P13
	57-203	H.B.	IA-2103	35	P13
	57-203	H.B.	IA-2116	30-45	P13
	57-203	H.B.	IA-2128	35	P13
	57-203	H.B.	IA-2603	30	P15
	57-203	H.B.	IA-2610	35	P15
	57-203	H.B.	IA-2611	26	P15
	57-203	H.B.	IA-2617	28	P15
	57-203	H.B.	SA-001	35	P15
	12 1/2x2.40	64-203	H.B.	IA-2056	40
12 1/2x3.0	—	S.S.	IA-2021	35	P11
12X1.75	47-203	S.S.	IA-2579	35-85	P15
12X2.0	50-203	H.B.	IA-2579	35-55	P15
14x 1 3/8x1 5/8	44-288	S.S.	HV-1213	40	P11
14x1.75	47-254	H.B.	HV-5102	35-40	P11
	47-254	H.B.	IA-2603	28-35	P15
14x2.0	50-254	H.B.	IA-2579	35-55	P15
14x2.10	54-254	H.B.	IA-2128	35-65	P13
14x2.125	57-254	H.B.	HV-5104	35	P11
	57-254	H.B.	HV-5102	35-40	P11
14x2.25	58-254	H.B.	IA-2610	35-65	P15
14x2.40	64-254	H.B.	IA-2021	40	P11
16x1.75	47-305	H.B.	HV-5102	35	P11
	47-305	H.B.	IA-2028	35	P12
	47-305	H.B.	IA-2094	35-45	P13
	47-305	H.B.	IA-2101	35	P13
	47-305	H.B.	IA-2103	35	P13
	47-305	H.B.	IA-2128	35	P13
	47-305	H.B.	IA-2603	35	P15
	47-305	H.B.	SA-001	35	P15
16x1.95	—	H.B.	HV-5104	35	P11
16x2.0	50-305	H.B.	IA-2579	35-55	P15
16x2.10	54-305	H.B.	IA-2128	35-65	P13
16x2.125	57-305	H.B.	HV-5102	35	P11
	57-305	H.B.	HV-5104	35	P11
	57-305	H.B.	IA-2027	35	P11
	57-305	H.B.	IA-2094	43	P13
	57-305	H.B.	IA-2101	35	P13
	57-305	H.B.	IA-2116	35	P13
	58-305	H.B.	IA-2021	40	P08
	57-305	H.B.	IA-2094	35	P13
16x2.25	58-305	H.B.	IA-2603	35	P15
16x2.40	64-305	H.B.	IA-2021	40	P11
	60-305	H.B.	IA-2610	35-60	P15
18x1.75	64-305	H.B.	IA-2021	40	P11
	47-355	H.B.	IA-2028	35	P12
47-355	H.B.	HV-5102	35-40	P11	

BMX

SIZE(INCH)	SIZE(MM)	RIM TYPE	PATTERN	P.S.I	PAGES
18x2.0	50-355	H.B.	IA-2579	35-55	P15
18x2.10	54-355	H.B.	IA-2128	35-60	P13
18x2.125	57-355	H.B.	HV-5104	35	P11
	57-355	H.B.	IA-2080	35	P12
18x2.25	57-355	H.B.	IA-2021	40	P11
	57-355	H.B.	IA-2094	35	P13
18x2.40	60-355	H.B.	IA-2610	35-60	P15
20x1.50	40-406	H.B.	IA-2040	40-65	P12
20x1.75	47-406	H.B.	HV-5102	35	P11
	47-406	H.B.	IA-2090	35	P12
	47-406	H.B.	IA-2101	35	P13
	47-406	H.B.	IA-2104	50	P13
	47-406	H.B.	IA-2128	35	P13
	47-406	H.B.	IA-2501	40-65	P14
	47-406	H.B.	IA-2502	35	P14
	47-406	H.B.	IA-2603	35	P15
20x1.90	52-406	H.B.	IA-2239	65	P14
20x1.95	50-406	H.B.	HV-5104	35	P11
	54-406	H.B.	IA-2031	35	P12
20x2.0	53-406	H.B.	IA-2116	40-85	P13
	54-406	H.B.	IA-2021	40	P11
	54-406	H.B.	IA-2028	40	P12
	54-406	H.B.	IA-2032	40	P12
	54-406	H.B.	IA-2040	40-65	P12
	54-406	H.B.	IA-2041	40	P12
	54-406	H.B.	IA-2072	40	P12
	54-406	H.B.	IA-2096	40	P13
	50-406	H.B.	IA-2127	35-60	P13
	50-406	H.B.	IA-2128	35-60	P13
	50-406	H.B.	IA-2248	35-60	P14
	50-406	H.B.	IA-2249	35-60	P14
20x2.10	54-406	H.B.	IA-2501	40	P14
	54-406	H.B.	IA-2502	40-65	P14
	54-406	H.B.	IA-2503	40	P14
	54-406	H.B.	IA-2505	40-65	P14
	54-406	H.B.	IA-1213	35-60	P11
	54-406	H.B.	IA-2031	40	P12
	57-406	H.B.	IA-2239	29-65	P14
	54-406	H.B.	IA-2131	35-60	P14
20x2.125	57-406	H.B.	HV-5102	35	P11
	57-406	H.B.	HV-5104	35	P11
	57-406	H.B.	IA-1211	40	P11
	54-406	H.B.	IA-2030	40-65	P12
	54-406	H.B.	IA-2031	35	P12
	58-406	H.B.	IA-2047	40	P12
	58-406	H.B.	IA-2090	35	P12
	57-406	H.B.	IA-2101	35	P13
	57-406	H.B.	IA-2104	40	P13
	57-406	H.B.	IA-2105	35	P13
	54-406	H.B.	IA-2249	35-60	P14
	57-406	H.B.	IA-2533	35	P14
20x2.25	57-406	H.B.	IA-2534	35	P15
	57-406	H.B.	IA-2535	35	P15

BMX

SIZE(INCH)	SIZE(MM)	RIM TYPE	PATTERN	P.S.I	PAGES
20x2.20	58-406	H.B.	IA-2096	35-60	P13
	58-406	H.B.	IA-2127	35-60	P13
	56-406	H.B.	IA-2128	35-60	P13
20x2.25	58-406	H.B.	IA-2021	40	P11
	58-406	H.B.	IA-2248	35-60	P14
	58-406	H.B.	IA-2505	40	P14
	58-406	H.B.	IA-2131	45	P14
20x2.30	58-406	H.B.	IB-3009	35-60	P15
	58-406	H.B.	IA-2128	35-60	P13
20x2.35	58-406	H.B.	IA-2021	35	P11
20x2.40	64-406	H.B.	IA-2021	40	P08
	60-406	H.B.	IA-2128	35-60	P13
	60-406	H.B.	IA-2610	35-60	P15
	60-406	H.B.	IB-3009	35-60	P15
20x2.50	67-387	H.B.	IA-2021	35-60	P13
22x2.125	57-456	H.B.	IA-2505	80	P14
22x1.75	47-456	H.B.	IA-2603	40-65	P15
22x2.3	58-456	H.B.	IA-2128	35-60	P13
24x1.50	40-507	H.B.	IA-2040	40-65	P12
24x1.75	47-507	H.B.	HV-5102	40-65	P11
	47-507	H.B.	IA-2080	40-65	P12
	47-507	H.B.	IA-2603	40-65	P15
24x1.95	50-507	H.B.	IA-2249	40-65	P14
24x2.0	40-507	H.B.	IA-2128	40-65	P13
24x2.125	57-507	H.B.	HV-5102	40-65	P11
26x1.95	54-559	H.B.	IA-2021	40-65	P11
26x2.0	50-559	H.B.	IA-2128	35-60	P13
26x2.10	56-559	H.B.	IA-2021	40-65	P11
26x2.125	57-559	H.B.	HV-5102	40-65	P11
26x2.2	56-559	H.B.	IA-2128	35-60	P13
26x2.30	58-559	H.B.	HV-5102	30-80	P11
	58-559	H.B.	IA-2610	35-60	P15
26x2.50	67-559	H.B.	IA-2021	40-65	P11
	62-559	H.B.	IA-2096	30-50	P13
26x3.0	68-559	H.B.	IA-2047	40	P12
27 5/8x2.3	58-584	S.S.	IA-2128	35-60	P13
29x2.3	58-622	S.S.	IA-2128	35-60	P13
29x2.5	62-622	S.S.	IA-2096	35-60	P13

MTB

SIZE(INCH)	SIZE(MM)	RIM TYPE	PATTERN	P.S.I	PAGES
12 1/2x2 1/4	57-203	S.S.	IA-2004	35	P16
	57-203	S.S.	IA-2005	35	P16
12 x2.25	58-203	H.B.	IB-3014	35-65	P20
14x2.10	54-254	H.B.	IA-2569	35-65	P20
14x2.125	57-254	H.B.	IA-2004	25-35	P16
14 x2.25	58-254	H.B.	IB-3014	35-65	P20
16x1.35	37-305	S.S.	IA-2023	85	P18
16x1.75	47-305	H.B.	IA-2007	35	P17
16x1.95	54-305	H.B.	IA-2004	35	P16
	54-305	H.B.	IA-2015	35	P17
16x2.0	54-305	H.B.	IA-2024	35	P18
16x2.10	56-305	H.B.	IA-2003	35	P16
	54-305	H.B.	IA-2569	35-65	P20
16x2.125	57-305	H.B.	IA-2004	35	P16
	57-305	H.B.	IA-2005	35	P16
	57-305	H.B.	IA-2016	35	P17
16x2.25	57-305	H.B.	IA-2020	35	P18
	58-305	H.B.	IB-3014	35-65	P20
18x1.75	47-355	H.B.	IA-2007	40-65	P17
18x1.95	54-355	H.B.	IA-2004	35	P16
18x2.10	56-355	H.B.	IA-2003	35	P16
18x2.125	55-355	H.B.	IA-2569	35-65	P20
18x2.25	58-355	H.B.	IB-3014	35-65	P20
18x2.40	60-355	H.B.	IB-3014	35-60	P20
20x1.35	37-406	S.S.	IA-2023	85	P18
20x1.75	47-406	H.B.	HV-5002	35	P16
	47-406	H.B.	IA-2004	35	P16
	47-406	H.B.	IA-2005	35	P16
	47-406	H.B.	IA-2007	35	P17
20x1.95	54-406	H.B.	IA-2004	35	P16
	54-406	H.B.	IA-2015	35	P17
	54-406	H.B.	IA-2016	35	P17
	50-406	H.B.	IA-2549	35	P19
	54-406	H.B.	IA-2005	40	P16
20x2.0	54-406	H.B.	IA-2012	40	P17
	54-406	H.B.	IA-2022	40	P18
	54-406	H.B.	IA-2024	40	P18
	54-406	H.B.	IA-2070	40	P18
	50-406	H.B.	IA-2569	35-65	P20
20x2.10	56-406	H.B.	IA-2003	40	P16
	57-406	H.B.	IA-2004	40	P16
	54-406	H.B.	IA-1130	35-65	P16
20x2.125	56-406	H.B.	IB-2003	40	P20
	53-406	H.B.	HV-5002	35	P16
20x2.25	54-406	H.B.	IA-2004	35	P16

MTB

SIZE(INCH)	SIZE(MM)	RIM TYPE	PATTERN	P.S.I	PAGES
24x1.75	47-507	H.B.	HV-5002	40-65	P16
	47-507	H.B.	IA-2003	40-65	P16
	47-507	H.B.	IA-2004	40-65	P16
	47-507	H.B.	IA-2007	40-65	P17
	47-507	H.B.	IA-2014	40-65	P17
24x1.90	47-507	H.B.	HV-5002	40-65	P16
	47-507	H.B.	IA-2004	40-65	P16
24x1.95	54-507	H.B.	IA-2001N	40-65	P16
	54-507	H.B.	IA-2003	40-65	P16
	54-507	H.B.	IA-2004	40-65	P16
	54-507	H.B.	IA-2005	40-65	P16
	57-507	H.B.	IA-2005A	40-65	P16
24x2.0	54-507	H.B.	IA-2007	40-65	P17
	54-507	H.B.	IA-2011	40-65	P17
	54-507	H.B.	IA-2026	40-65	P18
	50-507	H.B.	IA-2549	40-65	P19
	54-507	H.B.	IA-2016	40-65	P17
24x2.10	54-507	H.B.	IA-2022	40-65	P18
	54-507	H.B.	IA-2024	40-65	P18
	54-507	H.B.	IA-2070	40-65	P18
	50-507	H.B.	IA-2561	35-65	P20
	50-507	H.B.	IA-2569	40-65	P20
24x2.125	54-507	H.B.	IA-1130	35-65	P16
	56-507	H.B.	IA-2001N	40-65	P16
	56-507	H.B.	IA-2003	40-65	P16
	56-507	H.B.	IA-2004	40-65	P16
	56-507	H.B.	IA-2010	40-65	P17
24x2.25	54-507	H.B.	IB-2003	30-60	P20
	53-507	H.B.	HV-5002	40-65	P16
24x2.35	57-507	H.B.	IA-2006	40	P16
	53-507	H.B.	IB-3014	35-65	P20
24x2.80	59-507	H.B.	IA-2024	40-65	P18
	58-507	H.B.	IA-2530	40-65	P19
26x1.50	70-507	S.S.	IB-3014	15-30	P20
	47-559	H.B.	IA-2005	40-65	P16
26x1.75	47-559	H.B.	IA-2003	40-65	P16
	47-559	H.B.	IA-2004	40-65	P16
	47-559	H.B.	IA-2005	40-65	P16
	47-559	H.B.	IA-2007	40-65	P17
	50-559	H.B.	IA-2013	40-65	P17
26x1.90	47-559	H.B.	IA-2014	40-65	P17
	47-559	H.B.	IA-2549	35-65	P19
	47-559	H.B.	IA-2562	35-65	P20
	50-559	H.B.	HV-5002	40-65	P16
	50-559	H.B.	IA-2004M	40-65	P16
26x1.95	50-559	H.B.	IA-2005	40-65	P16
	50-559	H.B.	IA-2013	40-65	P17
	53-559	H.B.	HV-5002	40-65	P16
	54-559	H.B.	IA-2001	40-65	P16
	54-559	H.B.	IA-2001N	40-65	P16
26x2.0	54-559	H.B.	IA-2003	35	P16
	54-559	H.B.	IA-2004	40-65	P16
	54-559	H.B.	IA-2005	40-65	P16
	54-559	H.B.	IA-2005A	40-65	P16
	54-559	H.B.	IA-2007	40-65	P17
26x2.10	54-559	H.B.	IA-2010	40-65	P17
	54-559	H.B.	IA-2011	40-65	P17
	53-559	H.B.	HV-5002	40-65	P16
	54-559	H.B.	IA-2001	40-65	P16
	54-559	H.B.	IA-2001N	40-65	P16
26x2.125	54-559	H.B.	IA-2003	35	P16
	54-559	H.B.	IA-2004	40-65	P16
	54-559	H.B.	IA-2005	40-65	P16
	54-559	H.B.	IA-2005A	40-65	P16
	54-559	H.B.	IA-2007	40-65	P17
26x2.20	54-559	H.B.	IA-2010	40-65	P17
	54-559	H.B.	IA-2011	40-65	P17
	53-559	H.B.	HV-5002	40-65	P16
	54-559	H.B.	IA-2001	40-65	P16
	54-559	H.B.	IA-2001N	40-65	P16
26x2.25	54-559	H.B.	IA-2003	35	P16
	54-559	H.B.	IA-2004	40-65	P16
	54-559	H.B.	IA-2005	40-65	P16
	54-559	H.B.	IA-2005A	40-65	P16
	54-559	H.B.	IA-2007	40-65	P17
26x2.35	54-559	H.B.	IA-2010	40-65	P17
	54-559	H.B.	IA-2011	40-65	P17
	53-559	H.B.	HV-5002	40-65	P16
	54-559	H.B.	IA-2001	40-65	P16
	54-559	H.B.	IA-2001N	40-65	P16
26x2.4	54-559	H.B.	IA-2003	35	P16
	54-559	H.B.	IA-2004	40-65	P16
	54-559	H.B.	IA-2005	40-65	P16
	54-559	H.B.	IA-2005A	40-65	P16
	54-559	H.B.	IA-2007	40-65	P17
26x2.8	54-559	H.B.	IA-2010	40-65	P17
	54-559	H.B.	IA-2011	40-65	P17
	53-559	H.B.	HV-5002	40-65	P16
	54-559	H.B.	IA-2001	40-65	P16
	54-559	H.B.	IA-2001N	40-65	P16
27.5x1.95	54-559	H.B.	IA-2003	40-65	P16
	54-559	H.B.	IA-2004	40-65	P16
	54-559	H.B.	IA-2005	40-65	P16
	54-559	H.B.	IA-2007	40-65	P17
	54-559	H.B.	IA-2011	40-65	P17
27.5x2.0	54-559	H.B.	IA-2013	40-65	P17
	54-559	H.B.	IA-2014	40-65	P17
	54-559	H.B.	IA-2026	40-65	P18
	54-559	H.B.	IA-2063	40-65	P18
	54-559	H.B.	IA-2111	40-65	P18
27.5x2.25	54-559	H.B.	IA-2112	40-65	P18
	50-559	S.S.	IA-1131	35-65	P16
	54-559	H.B.	IA-2012	40-65	P17
	54-559	H.B.	IA-2016	40-65	P17
	54-559	H.B.	IA-2017	40-65	P17
27.5x2.35	54-559	H.B.	IA-2019	40-65	P17
	54-559	H.B.	IA-2020	40-65	P18
	54-559	H.B.	IA-2022	40-65	P18
	54-559	H.B.	IA-2023	40-65	P18
	54-559	H.B.	IA-2024	40-65	P18
27.5x2.8	54-559	H.B.	IA-2071	40-65	P18
	54-559	H.B.	IA-2530	40-65	P19
	54-559	H.B.	IA-2531	40-65	P19
	54-559	H.B.	IA-2540	40-65	P19
	54-559	H.B.	IA-2542	40-65	P19
29x1.95	54-559	H.B.	IA-2545	29-65	P19
	50-559	H.B.	IA-2548	29-65	P19
	50-559	H.B.	IA-2549	35-65	P19
	50-559	H.B.	IA-2552	35-65	P19
	50-559	H.B.	IA-2551	35-65	P20
29x2.0	50-559	H.B.	IA-2562	35-65	P17
	54-559	H.B.	IA-1130	35-65	P16
	56-559	H.B.	IA-2001N	40-65	P16
	54-559	S.S.	IB-2157	30-60	P20
	56-559	H.B.	IA-2003	40-65	P16
29x2.10	54-559	S.S.	IB-2003	30-60	P20
	57-559	H.B.	IA-2004	40-65	P16
	56-559	H.B.	IA-2005	40-65	P16
	56-559	H.B.	IA-2010	40-65	P17
	56-559	H.B.	IA-2113	40-65	P19
29x2.25	54-559	S.S.	IA-2568	35-65	P20
	54-559	S.S.	IA-2569	35-65	P20
	54-559	S.S.	IB-2003	30-60	P20
	57-559	H.B.	IA-2006	40	P16
	54-559	H.B.	IA-2548	29-65	P19
29x2.4	58-559	H.B.	IA-2549	35-65	P19
	58-559	S.S.	IA-2569	30-65	P20
	58-559	H.B.	IB-3014	35-65	P20
	59-559	H.B.	IA-2005	40-65	P16
	58-559	H.B.	IA-2024	40-65	P18
700x35C (28x1 5/8x1 1/2)	58-559	H.B.	IA-2530	40-65	P19
	58-559	H.B.	IA-2531	40-65	P19
	58-559	H.B.	IA-2540	40-65	P19
	58-559	H.B.	IA-2542	40-65	P19
	57-559	H.B.	IA-2004	40-65	P16
700x38C	56-559	H.B.	IA-2005	40-65	P16
	56-559	H.B.	IA-2010	40-65	P17
	56-559	H.B.	IA-2011	40-65	P17
	56-559	H.B.	IA-2113	40-65	P19
	54-559	S.S.	IA-2568	35-65	P20
700x42C	54-559	S.S.	IA-2569	35-65	P20
	54-559	S.S.	IB-2003	30-60	P20
	57-559	H.B.	IA-2004	40-65	P16
	56-559	H.B.	IA-2005	40-65	P16
	56-559	H.B.	IA-2010	40-65	P17
700x45C (28x1.75)	56-559	H.B.	IA-2011	40-65	P17
	56-559	H.B.	IA-2113	40-65	P19
	54-559	S.S.	IA-2568	35-65	P20
	54-559	S.S.	IA-2569	35-65	P20
	54-559	S.S.	IB-2003	30-60	P20
29x2.25	57-559	H.B.	IA-2006	40	P16
	54-559	H.B.	IA-2548	29-65	P19
	58-559	H.B.	IA-2549	35-65	P19
	58-559	S.S.	IA-2569	30-65	P20
	58-559	H.B.	IB-3014	35-65	P20
29x2.4	59-559	H.B.	IA-2005	40-65	P16
	58-559	H.B.	IA-2024	40-65	P18
	58-559	H.B.	IA-2530	40-65	P19
	58-559	H.B.	IA-2545	29-65	P19
	57-559	H.B.	IA-2552	35-65	P19
700x32C (28x1 5/8x1 1/4)	60-559	S.S.	IA-2569	30-65	P20
	70-559	S.S.	IB-3014	15-30	P20
	50-584	S.S.	IA-2549	35-65	P19
	50-584	H.B.	IA-2562	30-60	P20
	50-584	H.B.	IA-2562	30-60	P20

MTB

SIZE(INCH)	SIZE(MM)	RIM TYPE	PATTERN	P.S.I	PAGES
26x1.95	54-559	H.B.	IA-2013	40-65	P17
	54-559	H.B.	IA-2014	40-65	P17
	54-559	H.B.	IA-2026	40-65	P18
	54-559	H.B.	IA-2063	40-65	P18
	54-559	H.B.	IA-2111	40-65	P18
26x2.0	54-559	H.B.	IA-2112	40-65	P18
	50-559	S.S.	IA-1131	35-65	P16
	54-559	H.B.	IA-2012	40-65	P17
	54-559	H.B.	IA-2016	40-65	P17
	54-559	H.B.	IA-2017	40-65	P17
26x2.10	54-559	H.B.	IA-2019	40-65	P17
	54-559	H.B.	IA-2020	40-65	P18
	54-559	H.B.	IA-2022	40-65	P18
	54-559	H.B.	IA-2023	40-65	P18
	54-559	H.B.	IA-2024	40-65	P18
26x2.125	54-559	H.B.	IA-2071	40-65	P18
	54-559	H.B.	IA-2530	40-65	P19
	54-559	H.B.	IA-2531	40-65	P19
	54-559	H.B.	IA-2540	40-65	P19
	54-559	H.B.	IA-2542	40-65	P19
26x2.20	54-559	H.B.	IA-2545	29-65	P19
	50-559	H.B.	IA-2548	29-65	P19
	50-559	H.B.	IA-2549	35-65	P19
	50-559	H.B.	IA-2552	35-65	P19
	50-559	H.B.	IA-2551	35-65	P20
26x2.25	50-559	H.B.	IA-2562	35-65	P17
	54-559	H.B.	IA-1130	35-65	P16
	56-559	H.B.	IA-2001N	40-65	P16
	54-559	S.S.	IB-2157	30-60	P20
	56-559	H.B.	IA-2003	40-65	P16
26x2.35	54-559	S.S.	IB-2003	30-60	P20
	57-559	H.B.	IA-2004	40-65	P16
	56-559	H.B.	IA-2005	40-65	P16
	56-559	H.B.	IA-2010	40-65	P17
	56-559	H.B.	IA-2113	40-65	P19
26x2.4	54-559	S.S.	IA-2568	35-65	P20
	54-559	S.S.	IA-2569	35-65	P20
	54-559	S.S.	IB-2003	30-60	P20
	57-559	H.B.	IA-2006	40	P16
	54-559	H.B.	IA-2548	29-65	P19
26x2.8	58-559	H.B.	IA-2549	35-65	P19
	58-559	S.S.	IA-2569	30-65	P20
	58-559	H.B.	IB-3014	35-65	P20
	59-559	H.B.	IA-2005	40-65	P16
	58-559	H.B.	IA-2024	40-65	P18
27.5x1.95	58-559	H.B.	IA-2530	40-65	P19
	58-559	H.B.	IA-2545	29-65	P19
	57-559	H.B.	IA-2552	35-65	P19
	60-559	S.S.	IA-2569	30-65	P20
	70-559	S.S.	IB-3014	15-30	P20

General Data

General Data

CITY

SIZE(INCH)	SIZE(MM)	RIM TYPE	PATTERN	P.S.I	PAGES
22x1 3/4	44-501	S.S.	IA-2202	50	P23
22x1.50	40-456	S.S.	IA-2084	40-65	P23
22x1.75	47-456	H.B.	IA-2084	40-65	P23
22x2.50	—	H.B.	IA-2065	40	P22
24x1.25	32-507	H.B.	IA-2406	60-95	P24
24x1 3/8	37-540	S.S.	HV-5204	45	P22
	37-540	S.S.	IA-2074	45	P23
	37-540	S.S.	IA-2084	45	P23
	37-540	S.S.	IA-2202	65	P23
	37-540	S.S.	IA-2205	45	P23
24x1.50	37-540	S.S.	IA-2210B	65	P23
	37-540	S.S.	IA-2401	45	P24
	40-507	H.B.	IA-2018	40-65	P22
	40-507	H.B.	IA-2084	40-65	P23
	40-507	H.B.	IA-2209	40-65	P23
24x1.75	40-507	H.B.	IB-3010	50-75	P25
	47-507	H.B.	IA-2008	40-65	P22
	47-507	H.B.	IA-2009	40-65	P22
	47-507	H.B.	IA-2066	45-65	P22
	47-507	H.B.	IA-2067	45-65	P22
24x1.95	47-507	H.B.	IA-2084	40-65	P23
	47-507	H.B.	IA-2209	40-65	P23
	47-507	H.B.	IB-3016	30-60	P25
	54-507	H.B.	IA-2066	40-65	P22
	50-507	H.B.	IB-3010	35-65	P25
24x2.0	54-507	H.B.	IA-2018	40-65	P22
	52-507	H.B.	IA-2150	40-65	P25
24x2.10	57-507	H.B.	HV-5189	40-65	P22
	57-507	H.B.	IA-2065	40-65	P22
24x2.125	57-507	H.B.	IA-2236	35-65	P24
24x3.0	72-507	H.B.	HV-5189	40-65	P22
	76-507	H.B.	IA-2018	40-65	P22
	74-507	H.B.	IA-2236	40-65	P24
	37-590	S.S.	HV-5204	300kba	P22
	37-590	S.S.	IA-2054	65	P22
26x1 3/8	37-590	S.S.	IA-2074	45	P23
	37-590	S.S.	IA-2084	45	P23
	37-590	S.S.	IA-2202	60/300kba	P23
	37-590	S.S.	IA-2205	45	P23
	37-590	S.S.	IA-2209	300kba	P23
	37-590	S.S.	IA-2210B	43	P23
	37-590	S.S.	IA-2401	65	P24
	37-590	S.S.	IA-2403	300kba	P24
	37-590	S.S.	IA-2403	50	P24
	37-590	S.S.	IA-2403	50	P24
26x1 1/2	40-584	S.S.	IA-2403	50	P24
26x1 5/8x1 1/2	44-584	S.S.	IA-2403	40-65	P24
26x1 3/4	44-590	S.S.	IA-2210B	50	P23
26x1.25	32-559	H.B.	IA-2018	100kba	P22
	32-559	H.B.	IA-2406	60-95	P24
	40-559	H.B.	IA-2018	40-65	P22
26x1.50	40-559	H.B.	IA-2084	40-65	P23
	40-559	H.B.	IA-2209	40-65	P23
	40-559	H.B.	IA-2231	65	P23
	40-559	H.B.	IA-2235	40-65	P24
	40-559	H.B.	IA-2245	29-65	P24
	40-559	H.B.	IA-2251	40-65	P24
	40-559	H.B.	IA-2608	40-65	P25
40-559	H.B.	IB-3010	50-75	P25	

CITY

SIZE(INCH)	SIZE(MM)	RIM TYPE	PATTERN	P.S.I	PAGES
26x1.60	40-559	H.B.	IB-3010	50-75	P22
	41-559	H.B.	IA-2084	40-65	P23
	47-559	H.B.	IA-2018	40-65	P22
	47-559	H.B.	IA-2066	40-65	P22
	47-559	H.B.	IA-2067	40-65	P22
	47-559	H.B.	IA-2068	40-65	P22
	47-559	H.B.	IA-2084	40-65	P23
	47-559	H.B.	IA-2209	40-65	P23
	47-559	H.B.	IA-2231	40-65	P23
	47-559	H.B.	IA-2235	29-65	P24
26x1.75	47-559	H.B.	IB-3016	30-60	P25
	50-559	H.B.	IA-2008	40-65	P22
	54-559	H.B.	IA-2018	40-65	P22
	54-559	H.B.	IA-2066	40-65	P22
	54-559	H.B.	IA-2235	40-65	P24
26x1.90	52-559	H.B.	IA-2236	40-65	P24
	50-559	H.B.	IA-2245	65	P24
	57-559	H.B.	IA-2008	40-65	P22
	57-559	H.B.	IA-2073	40-65	P23
26x2.0	57-559	H.B.	IA-2236	35-65	P24
	59-559	H.B.	IA-2018	40-65	P22
	59-559	H.B.	IA-2236	40-65	P24
26x2.125	57-559	H.B.	IA-2008	40-65	P22
26x2.35	57-559	H.B.	IA-2066	40-65	P22
	57-559	H.B.	IA-2236	40-65	P24
26x2.8	71-559	S.S.	IA-2084	20-45	P23
26x3.0	76-559	S.S.	IA-2236	40-65	P24
27x1 1/4	32-630	S.S.	IA-2202	65	P23
	32-630	S.S.	IA-2403	65-95	P24
27x1 3/8	37-630	S.S.	IA-2202	50-75	P23
	37-630	S.S.	IA-2205	45	P23
	37-630	S.S.	IA-2210B	45	P23
27x1 1/2	40-609	S.S.	IA-2403	50	P24
27.5x1.50	40-584	S.S.	IA-2084	40-65	P23
27.5x1.75	47-584	S.S.	IA-2084	40-65	P23
27.5x2.0	50-584	S.S.	IA-2066	40-65	P22
650Bx47C	47-584	S.S.	IB-3016	30-60	P25
28x1 1/2	40-635	S.S.	HV-5204	50	P22
	40-635	S.S.	IA-2209	50	P23
28x1.75	47-622	H.B.	IA-2066	50-75	P22
	47-622	S.S.	IA-2403	50	P24
28x1 5/8x1 1/2	44-635	S.S.	IA-2403	50	P24
29x1.75(700x45C)	47-622	S.S.	IA-2084	40-65	P23
29x1.75(700x45C)	45-622	S.S.	IB-3025	45-65	P25
	45-622	S.S.	IB-3025	45-65	P25
29x2.15	55-622	S.S.	IB-3026	30-60	P22
700x28C (28x1 5/8x1 1/8)	28-622	S.S.	IA-2406	60-100	P24
700x32C (28x1 5/8x1 1/4)	32-622	S.S.	IA-2406	60-95	P24
	32-622	S.S.	IA-2562	60-95	P24
	32-622	S.S.	IA-2571	60-95	P25
	37-622	S.S.	IA-2406	50-90	P24
	37-622	S.S.	IA-2562	50-90	P24
700x35C (28x1 5/8x1 3/8)	37-622	S.S.	IA-2068	50-75	P22
	35-622	S.S.	IA-2084	50-75	P23
	37-622	S.S.	IA-2209	50-75	P23
	37-622	S.S.	IA-2235	50-75	P24
	37-622	S.S.	IA-2252	50-90	P24
	37-622	S.S.	IA-2401	50-75	P24
	37-622	S.S.	IA-2403	50-75	P24
	37-622	S.S.	IA-2403	50-75	P24
	37-622	S.S.	IA-2403	50-75	P24
	37-622	S.S.	IA-2403	50-75	P24

CITY

SIZE(INCH)	SIZE(MM)	RIM TYPE	PATTERN	P.S.I	PAGES
700x38C (28x1 5/8x1 1/2)	40-622	S.S.	IA-2066	50-75	P22
	40-622	S.S.	IA-2068	50-75	P22
	40-622	S.S.	IA-2084	50-75	P23
	40-622	S.S.	IA-2209	50-75	P23
	40-622	S.S.	IA-2231	65	P23
	40-622	S.S.	IA-2252	50-75	P24
	40-622	S.S.	IA-2401	50-75	P24
	40-622	S.S.	IA-2403	50-75	P24
	40-622	S.S.	IA-2562	50-75	P24
	40-622	S.S.	IA-2562	40-70	P24
29x1.75	47-622	S.S.	IA-2084	40-65	P23
700x40C	42-622	S.S.	IA-2066	50-75	P22
	42-622	S.S.	IA-2209	50-75	P23
	42-622	S.S.	IA-2216	50-75	P23
	42-622	S.S.	IA-2549	50-75	P24
700x42C	44-622	S.S.	IA-2066	50-75	P22
700x44C	44-622	S.S.	IA-2562	40-70	P24
700x45C (28x1.75) (28x1 5/8x1 3/4)	47-622	S.S.	IA-2066	50-75	P22
	47-622	S.S.	IA-2068	50-75	P22
	47-622	S.S.	IA-2209	50-75	P23
	47-622	S.S.	IA-2401	50-75	P24
	45-622	S.S.	IB-3010	30-60	P25
700x50C	45-622	S.S.	IB-3016	30-60	P25
	50-622	S.S.	IB-3010	30-60	P25
700x52C	52-622	S.S.	IA-2084	40-65	P23
	52-622	S.S.	IA-2209	40-65	P23
52-622	H.B.	IA-2150	40-65	P25	

ROAD

SIZE(INCH)	SIZE(MM)	RIM TYPE	PATTERN	P.S.I	PAGES
16x1 3/8	37-349	S.S.	IA-2886	50-85	P27
24x1	25-540	S.S.	IA-2806S	110	P27
25x1	25-559	S.S.	IA-2806S	110	P27
26x1	25-590	S.S.	IA-2806S	110	P27
27x1 1/4	32-630	S.S.	IA-2302	70	P26
700x20C (28x3/4)	20-622	S.S.	IA-2301	100	P26
700x22/23C (28x1)	23-622	S.S.	IA-2301	100	P26
700x22/23C	22/23-622	S.S.	IA-2304	100	P26
700x23C	23-622	S.S.	IA-2308	115-125	P27
	23-622	S.S.	IA-2309	115-125	P27
	23-622	S.S.	LA-002	115-125	P27
	23-622	S.S.	IA-2319	100-130	P27
	23-622	S.S.	IA-2318	100-130	P27
	25-622	S.S.	IA-2319	86-110	P27
	25-622	S.S.	IA-2318	86-110	P27
	25-622	S.S.	IA-2301	100	P26
	25-622	S.S.	IA-2304	100	P26
	25-622	S.S.	IA-2307	120	P27
700x25C	25-622	S.S.	IA-2886	120	P27
	25-622	S.S.	LA-002	120	P27
	25-622	S.S.	IA-2301	120	P26
	28-622	S.S.	IA-2319	60-100	P27
	28-622	S.S.	IA-2318	60-100	P27
	28-622	S.S.	IA-2318	60-100	P27

FAT & PLUS SIZE

SIZE(INCH)	SIZE(MM)	RIM TYPE	PATTERN	P.S.I	PAGES
12 1/2x3.0	—	S.S.	HV-5189	35	P28
	—	H.B.	IA-2021	35	P28
	—	S.S.	IA-2065	35	P29
16x3.0	72-305	H.B.	HV-5189	35	P28
	72-305	H.B.	IA-2065	35	P29
16x4.0	102-305	H.B.	LV-1003	35	P28
20x3.0	72-406	H.B.	HV-5189	35	P28
	72-406	H.B.	IA-2065	35	P29
	72-406	H.B.	IA-2098	35	P29
	76-406	H.B.	IA-2018	35	P28
	—	H.B.	IA-2077	35	P29
20x4.0	—	H.B.	IA-2577	35	P29
	—	H.B.	LV-1003	20	P28
	102-406	H.B.	IA-2152	20	P29
	102-406	H.B.	IA-2579	20	P29
	—	S.S.	IB-3014	20	P29
20x4.5	—	S.S.	IA-3025	35	P29
	—	S.S.	IA-3025	35	P29
20x4 1/4	—	S.S.	HV-5189	35	P28
	—	S.S.	IA-2065	35	P29
	—	H.B.	IA-2214A	—	P29
24x4.0	72-507	H.B.	HV-5189	40-65	P28
	74-507	H.B.	IA-2236	40-65	P29
	—	H.B.	IA-2077	40	P29
	76-507	H.B.	IA-2018	40-65	P28
	—	H.B.	LV-1003	35	P28
24x4.8	—	S.S.	LV-1001	—	P28
	—	S.S.	LV-1007	15	P28
26x3.0	68-559	H.B.	IA-2047	40	P28
	76-559	S.S.	IA-2610	35	P29
	74-559	H.B.	IA-2236	40-65	P29
26x4.0	—	S.S.	IA-2214A	30	P29
	—	S.S.	LV-1001	5-15	P28
	—	S.S.	LV-1002	5-15	P28
	—	S.S.	LV-1003E	5-15	P28
	—	S.S.	LV-1007	15	P28
26x4.8	102-559	S.S.	LV-1009	15	P28
	—	S.S.	LV-1008	5-15	P28
	102-559	S.S.	IA-2610	35	P29
	—	S.S.	LV-1008	5-15	P28
	—	S.S.	LV-1007	15	P28
27.5x2.8	70-584	S.S.	IB-3014	15-30	P29
	—				

General Data



MINI

SIZE(INCH)	SIZE(MM)	RIM TYPE	PATTERN	P.S.I	PAGES
10x2.125	—	S.S.	IA-2240	36	P30
16x1 1/4	32-349	S.S.	IA-2309	100	P30
16x1 3/8	37-349	S.S.	IA-2240	50-85	P30
16x1.50	40-305	H.B.	IA-2243	50-85	P30
18x1.25	32-355	H.B.	IA-2084N	70-115	P30
20x1 1/8	28-451	S.S.	IA-2312	100	P30
	—	S.S.	LA-007	—	P30
20x1.10	28-406	S.S.	IA-2242	100	P30
	28-451	S.S.	IA-2243	100	P30
20x1.35	37-406	S.S.	IA-2076	85	P30
	37-406	S.S.	IA-2245	100	P30
20x1.50	40-406	H.B.	IA-2040	85	P30
	40-406	H.B.	IA-2243	85	P30
20x1 3/8	37-451	S.S.	IA-2243	85	P30

BEACH

SIZE(INCH)	SIZE(MM)	RIM TYPE	PATTERN	P.S.I	PAGES
20x1.75	47-406	H.B.	IA-2069	35	P32
20x2.125	58-406	S.S.	IA-2069B	40	P32
22x1.75	47-456	H.B.	IA-2069	35	P32
24x2.125	54-507	H.B.	IA-2701	40-65	P32
	54-507	H.B.	IA-2702	35	P32
26x2.125	54-507	H.B.	IA-2704	40-65	P32
	57-559	H.B.	IA-2069	40-65	P32
	57-559	H.B.	IA-2701	40-65	P32
	57-559	H.B.	IA-2702	35	P32
	54-559	H.B.	IA-2703	40-65	P32
26x3.0	57-559	H.B.	IA-2704	40-65	P32
	76-559	S.S.	IA-2704	35-60	P32
27.5x2.35	58-584	H.B.	IA-2704	40-65	P32

SNOW

SIZE(INCH)	SIZE(MM)	RIM TYPE	PATTERN	P.S.I	PAGES
26x1 3/8	37-590	S.S.	IA-2903	65	P31
26x1.75/1.9	47-559	S.S.	IA-2902	40-65	P31
26x2.10	54-559	H.B.	IA-2901	40-65	P31
27.5x2.10	54-584	S.S.	IA-2572	35-65	P31
29x2.10	54-622	S.S.	IA-2572	35-65	P31
	54-622	S.S.	IA-2573	35-65	P31
700x35C	35-622	S.S.	IA-2902	50-75	P31
700x35C (28x1 5/8x1 3/8)	37-622	S.S.	IA-2908	50-75	P31
700x38C	40/44-622	S.S.	IA-2902	50-75	P31
700x45C (28x1.75) (28x1 5/8x1 3/4)	47-622	S.S.	IA-2902	35-65	P31
700x45C (28x1.75x1 3/4)	47-622	S.S.	IA-2908	75	P31



Pattern	Type	Pages	Pattern	Type	Pages	Pattern	Type	Pages	Pattern	Type	Pages
HV-1205	B	P11	IA-2054	C	P22	IA-2235	C	P24	IA-2563	M	P20
HV-1206	B	P11	IA-2056	B	P12	IA-2236	C	P24	IA-2564	M	P20
HV-1213	B	P11	IA-2063	M	P18	IA-2236	F	P29	IA-2568	M	P20
HV-5002	M	P16	IA-2065	C	P22	IA-2236	E	P07	IA-2569	M	P20
HV-5102	B	P11	IA-2065	F	P29	IA-2239	B	P14	IA-2569	F	P29
HV-5104	B	P11	IA-2066	C	P22	IA-2240	MI	P30	IA-2569	E	P07
HV-5189	E	P06	IA-2066	E	P08	IA-2242	MI	P30	IA-2571	C	P25
HV-5189	C	P22	IA-2067	C	P22	IA-2243	MI	P30	IA-2572	S	P31
HV-5189	F	P28	IA-2068	C	P22	IA-2245	MI	P30	IA-2573	S	P31
HV-5204	C	P22	IA-2068	E	P08	IA-2245	C	P24	IA-2577	F	P29
IA-1130	M	P16	IA-2069	E	P08	IA-2248	B	P14	IA-2579	B	P15
IA-1131	M	P16	IA-2069	BE	P32	IA-2248	E	P07	IA-2579	E	P07
IA-1211	B	P11	IA-2070	M	P18	IA-2249	B	P14	IA-2579	F	P29
IA-1213	B	P11	IA-2071	M	P18	IA-2251	C	P24	IA-2601	C	P25
IA-2001	M	P16	IA-2072	B	P12	IA-2252	C	P24	IA-2603	B	P15
IA-2001N	M	P16	IA-2073	C	P23	IA-2301	R	P26	IA-2608	C	P25
IA-2003	M	P16	IA-2074	C	P23	IA-2302	R	P26	IA-2610	B	P15
IA-2004	M	P16	IA-2076	MI	P30	IA-2304	R	P26	IA-2610	E	P07
IA-2005	M	P16	IA-2077	F	P29	IA-2307	R	P27	IA-2610	F	P29
IA-2005A	M	P16	IA-2080	B	P12	IA-2308	R	P27	IA-2611	B	P15
IA-2006	M	P16	IA-2084	C	P23	IA-2309	MI	P30	IA-2616	E	P06
IA-2007	M	P17	IA-2084	E	P08	IA-2309	R	P27	IA-2617	B	P15
IA-2008	C	P22	IA-2084N	MI	P30	IA-2312	MI	P30	IA-2701	BE	P32
IA-2009	C	P22	IA-2090	B	P12	IA-2401	C	P24	IA-2702	BE	P32
IA-2010	M	P17	IA-2094	B	P13	IA-2403	C	P24	IA-2703	BE	P32
IA-2011	M	P17	IA-2096	B	P13	IA-2406	C	P24	IA-2704	BE	P32
IA-2012	M	P17	IA-2098	F	P29	IA-2406	E	P08	IA-2806S	R	P27
IA-2013	M	P17	IA-2101	B	P13	IA-2501	B	P14	IA-2886	R	P27
IA-2014	M	P17	IA-2103	B	P13	IA-2502	B	P14	IA-2901	S	P31
IA-2015	M	P17	IA-2104	B	P13	IA-2503	B	P14	IA-2902	S	P31
IA-2016	M	P17	IA-2105	B	P13	IA-2505	B	P14	IA-2903	S	P31
IA-2017	M	P17	IA-2111	M	P18	IA-2530	M	P19	IA-2908	S	P31
IA-2018	E	P06	IA-2112	M	P18	IA-2531	M	P19	IA-3025	E	P06
IA-2018	C	P22	IA-2113	M	P19	IA-2533	B	P14	IA-3025	F	P29
IA-2018	F	P28	IA-2116	B	P13	IA-2534	B	P14	IB-2003	M	P16
IA-2019	M	P17	IA-2127	B	P13	IA-2535	B	P15	IB-2157	M	P20
IA-2020	M	P18	IA-2128	B	P13	IA-2540	M	P19	IB-3009	B	P15
IA-2021	B	P11	IA-2128	E	P06	IA-2542	M	P19	IB-3010	G	P21
IA-2021	F	P28	IA-2131	B	P14	IA-2545	M	P19	IB-3010	C	P25
IA-2022	M	P18	IA-2150	C	P25	IA-2548	M	P19	IB-3010	E	P08
IA-2023	M	P18	IA-2150	E	P09	IA-2549	M	P19	IB-3013	E	P09
IA-2024	M	P18	IA-2152	E	P07	IA-2549	C	P24	IB-3014	E	P07
IA-2026	M	P18	IA-2152	F	P29	IA-2549	E	P07	IB-3014	M	P20
IA-2027	B	P11	IA-2155	E	P06	IA-2549	G	P21	IB-3014	G	P21
IA-2028	B	P12	IA2202	C	P23	IA-2552	M	P19	IB-3014	F	P29
IA-2030	B	P12	IA-2205	C	P23	IA-2553	M	P19	IB-3016	G	P21
IA-2031	B	P12	IA-2209	C	P23	IA-2554	M	P20	IB-3016	C	P25
IA-2032	B	P12	IA-2209	E	P09	IA-2560	M	P20	IB-3016	E	P08
IA-2040	B	P12	IA-2209B	E	P09	IA-2561	M	P20	IB-3018	G	P21
IA-2040	MI	P30	IA-2210B	C	P23	IA-2562	M	P20	IB-3019	E	P09
IA-2041	B	P12	IA-2214A	F	P29	IA-2562	C	P24	IB-3020	E	P09
IA-2047	B	P12	IA-2216	C	P23	IA-2562	G	P21	IB-3025	C	P25
IA-2047	F	P28	IA-2231	C	P23	IA-2562	E	P08	IB-3025	E	P09



 **INNOVA RUBBER CO., LTD.**

Head Office

No.23,Jingcheng Rd.,Changhua 50027,Taiwan
Tel:886-4-7521037 Fax:886-4-7521062
E-mail:innova@innovatires.com.tw

Taiwn Factory

Factory: No. 59, Xingong 4th Rd., Tianzhong
Township, Changhua County 520003, Taiwan
Tel: 886-4-8762188 Fax:886-4-8762189

Bengbu Factory

Weiwu Rd.Guzhen Economic Development Zone,
233705 Bengbu,AnHui China
Tel:86-552-2121388 Fax:86-552-2121399

Pinghu Office

No 1668,Xingping 2'nd Rd.,Pinghu City,
314200 Zhejiang China
Tel:86-573-85626666 Fax:86-573-85025423

